

LINEAR 10W SINGLE COLOUR TOP BEND

NEON 1010



DESCRIPTION

Our Single Colour Top Bend LED NEON FLEX 1010 is crafted from Dow Chemical SILASTIC™ ET-7021 silicone rubber, offering exceptional transparency and strength. Manufactured using an integrated extrusion moulding process with environmental protection grade silicone, this product features a unique optical light distribution design for a uniform, shadow-free lighting surface. We use a matt finish that is anti-dust and more robust against UV exposure, ensuring long-lasting performance and maintaining a clean, high-quality appearance over time.

PRODUCT SPECIFICATION

Product Code	NT1010S3
Dimensions	W: 10mm, H: 10mm
Cutting Interval	50mm
Bend Direction	Top Bend
Minimum Bend Radius	≥75mm
Colour Temperature ¹	2700K, 3000K, 4000K, + More
Bin/step	Single Bin / 3SDCM
Lifetime	≥50,000 hours
Environment T _a	-25°C to 55°C
IP Rating	IP67
Mounting ²	Clips and Profile
Connection ¹	Injection Moulds
Certifications	UL, CE, RoHS

PERFORMANCE DATA

Power Consumption	10W/m
Supply Voltage	24V DC
Lumens/Metre ¹	831-885 Lm/m
Lumen Efficiency ¹	83.1-88.5 Lm/m
L70	161,000 hours
L80	102,000 hours
Max Length	7,000mm
Beam Angle	120°
CRI	92+
Dimmable	Yes

¹ See Page 2 for further information. More custom colour temperatures are available upon request.

² See Page 3 for further information.



UK BESPOKE MACHINE INJECTION MOULDING

Our factory-sealed ends ensure an ultra durable, waterproof and seamless installation

FIND OUT MORE



fossLED UK Operations Centre
Unit C9 & C10 Lakeside, Neptune Close,
Medway City Estate, Rochester, Kent,
ME2 4LT, United Kingdom



sales@fossled.co.uk
+44 (0)203 198 1908
www.fossled.com
V2-MS260511



SINGLE COLOUR TEMPERATURE DATA

CCT (K)	CRI	Voltage	Power (W/m)	Lumen (Lm/m)	Efficiency (Lm/W)	Unit Length (mm)	Max. Run Length (M)
2700K	92+	DC24V	10	831	83.1	50	7
3000K	92+	DC24V	10	868	86.8	50	7
4000K	92+	DC24V	10	885	88.5	50	7

The given data are typical values due to the tolerances of the production process and the electrical components, values for light output and electrical power can vary up to 10%.

DIMENSIONS [mm]

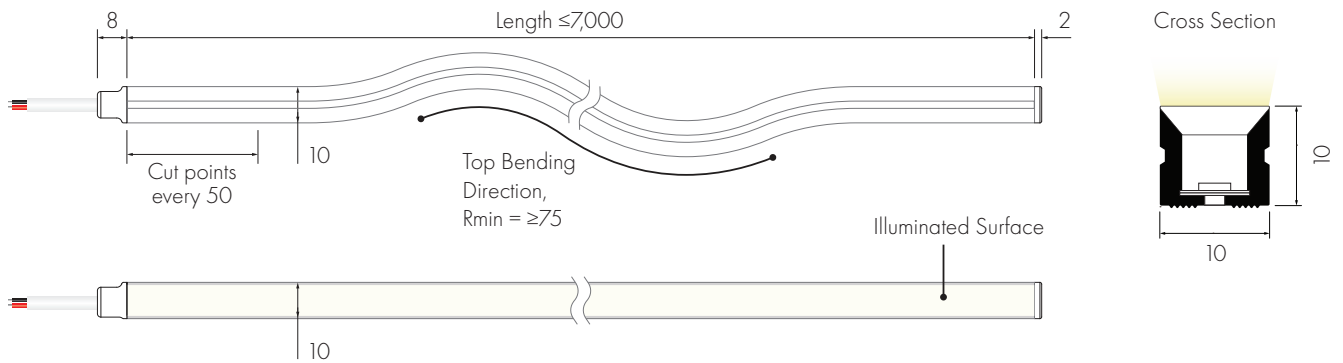

Shown with **FF** Front Feed and **EE** End Injection Moulds

CABLE FEED/END TYPES

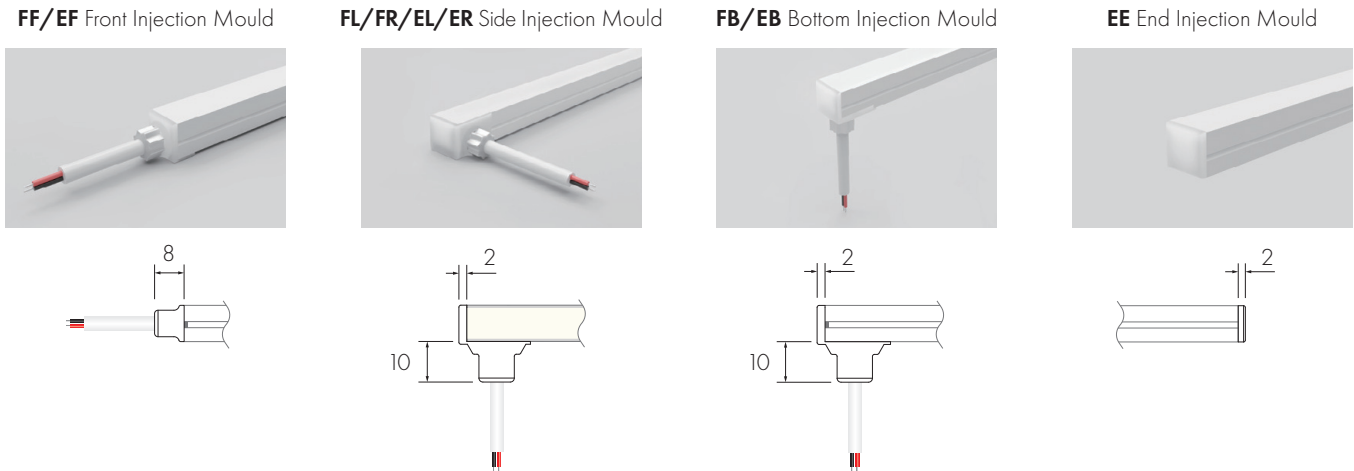

EES End Silicone Cap

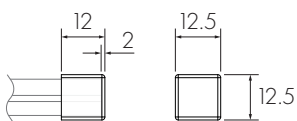
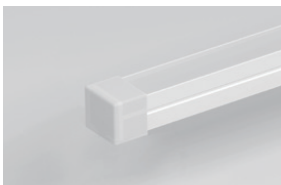

MOUNTING OPTIONS

Lightweight & Durable
MC1010-8 Aluminium Clips

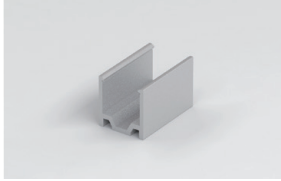

1 Clip supplied with M3 fixing screws
4 Clips recommended per metre

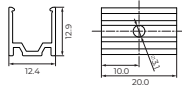

Robust & Long-lasting
MC1010-SS Stainless Steel Clips



1 Clip supplied with M3 fixing screws
4 Clips recommended per metre

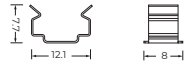

Discreet & Moisture Proof
MC1010-CL Transparent Clips

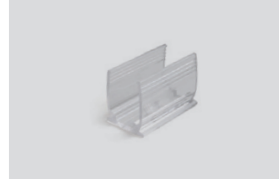

1 Clip supplied with M3 fixing screws
4 Clips recommended per metre

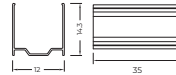

Lightweight & Durable
MP1010-81M Aluminium Profile

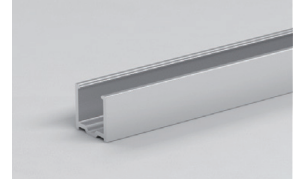

Supplied with M3 fixing screws
1 metre length



Discreet & Moisture Proof
MP1010-CL1M Transparent Plastic Profile

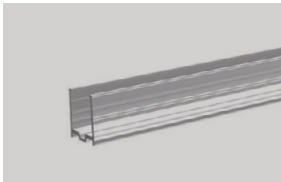

Supplied with M3 fixing screws
1 metre length



Adaptive Mounting
FP1010-81M Flexible Surface Profile



Supplied with M3 fixing screws
1 metre length



Adaptive & Flush
PPF1010-81M Flexible Plaster In



Supplied with M3 fixing screws
1 metre length

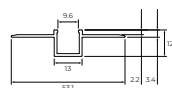

Edge Integration
SPFP1010-81M One Sided Flexible Plaster In

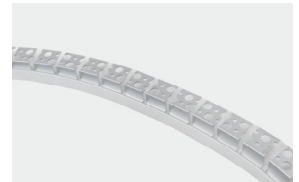

Supplied with M3 fixing screws
1 metre length

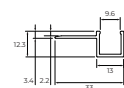

CABLE OPTIONS

Cable Type	Diagram	Specification	Core	Electrical Properties
White Silicone Cable		Outer Ø6.0mm/Inner cores 2 x 0.5mm ²		Red V+, Black V-
Black Silicone Cable		Outer Ø6.0mm/Inner cores 2 x 0.5mm ²		Red V+, Black V-

LIGHT DISTRIBUTION CURVE

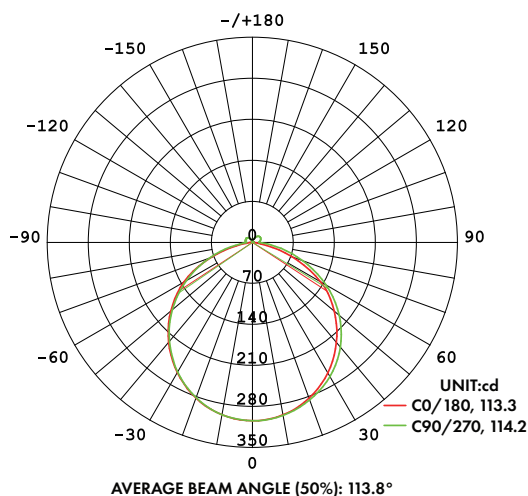

The given data is based on 24V, 10W/M, single colour with 4000k colour temperature.
If you need IES files for other types please contact our sales department.

NEON CUSTOMISATION

Follow the steps below, using our Customisation Sheet, to build your custom Neon product

[GO TO CUSTOMISATION SHEET](#) →

1

Confirm Nominal Code and select the required colour temperature

Nominal Code	Colour Temperature
NT1010S3 - Neon Top Bend 10x10mm Single Colour 10W	G <ul style="list-style-type: none"> ● G 2700K ● C 3000K ● N 4000K + More colour temperatures are available upon request

2

Choose the Product Length

Product Length
50mm Customised in increments set by the specified product cut points Please note that the finished length will be effected by Feed/End Type and specified tolerances

3

Choose Feed Type options

Feed Type	Feed Cable Length	Feed Cable Colour
FF <ul style="list-style-type: none"> FF Front IP67 FB Bottom IP67 FL Left Side IP67 FR Right Side IP67 	1m Customised in 1m increments	NR2C-0 <ul style="list-style-type: none"> ● NR2C-0 Feed White Silicone Cable ● NR2C-1 Feed Black Silicone Cable

4

Choose End Type options

End Type	End Cable Length	End Cable Colour
EE <ul style="list-style-type: none"> EE End IP67 EES End Silicone Cap IP67 EF Front IP67 EB Bottom IP67 EL Left Side IP67 ER Right Side IP67 	- Customised in 1m increments	- <ul style="list-style-type: none"> ● NR2C-0 End White Silicone Cable ● NR2C-1 End Black Silicone Cable

+

Add required Mounting options
If additional Joined Lengths are required then repeat steps 3 and 4

DEFINING FEED/END TYPES

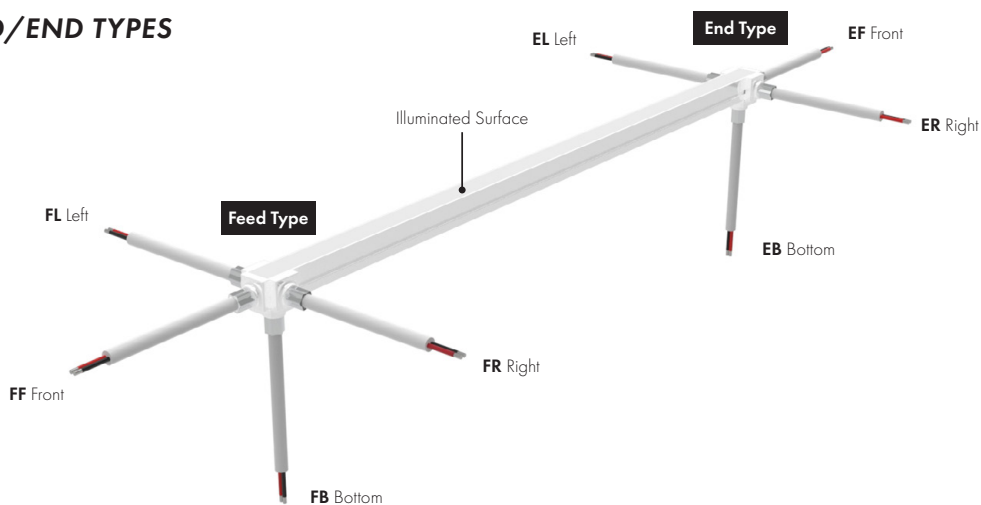

INJECTION MOULDS

Our injection moulded ends provide a seamless, waterproof, and ultra-durable solution for a superior lighting solution. Whether for architectural, commercial, or outdoor lighting applications, our factory-sealed ends ensure flawless performance, easy installation, and a professional finish—*expertly manufactured at our UK factory.*

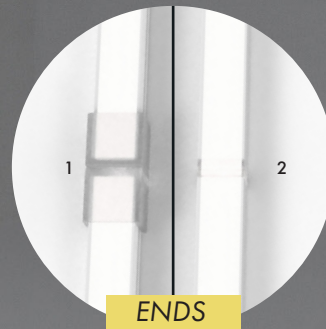

- 1 SILICONE CAP vs
- 2 INJECTION MOULD

Create a seamless finish at the end of runs and when butting two lengths together.

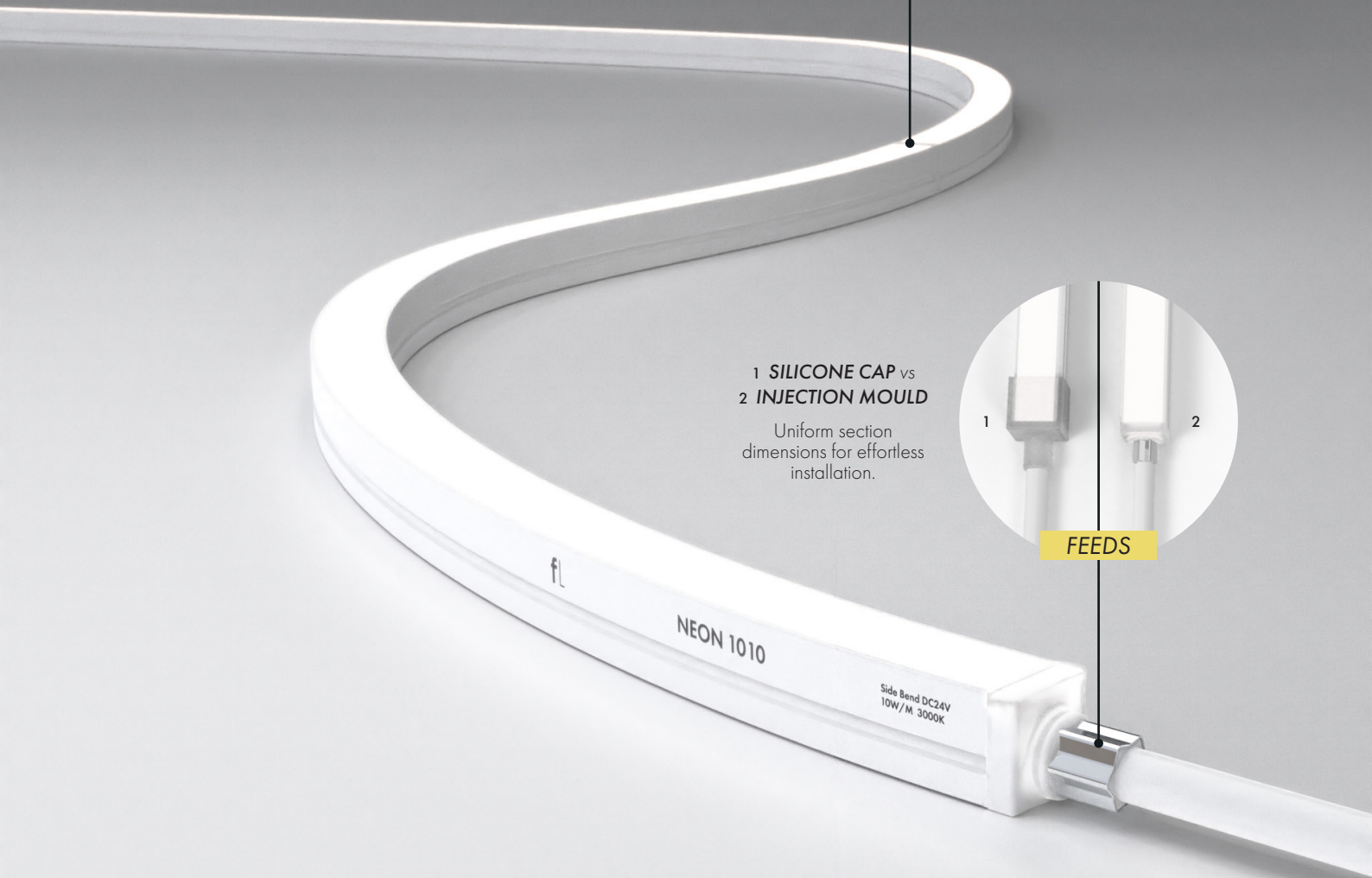

- 1 SILICONE CAP vs
- 2 INJECTION MOULD

Uniform section dimensions for effortless installation.

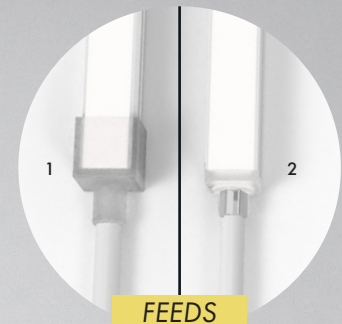

FEEDS

DURABILITY & PROTECTION

Injection moulded entries ensure a robust seal, preventing water ingress, dust contamination, and moisture via capillary action for long lasting protection.

AESTHETICS & FINISH

Injection moulded entries provide a seamless, professional finish, avoiding visible seams guaranteeing a consistent appearance across all installations.

EFFORTLESS INSTALLATION

With uniform section dimensions and no bulky connectors or uneven fittings, injection moulded ends make installation smooth, clean, and hassle-free.