

# Light Smart Receiver

4 Channel WIFI + RF Receiver RGBW  
FLDC4Y-WIFI



Compatible with all RGBW LED Strips.

fossLED WIFI receivers offer lighting control from your smart device in conjunction with fossLED Controllers.

Control your lighting from your IOS or Android device. Compatible with Amazon Alexa, Siri and Google Assistant.

Control multiple zones, save scenes, create schedules, remotely control your lighting and even match your lighting to music via the TUYA App.

Input Voltage: 12-24VDC.

Output: 4 x 3A (4 x 36-72W Max in 24VDC), see page 3 for a breakdown of the Wattage limitations for different LED Strip Types.

Optionally match with RF 2.4Ghz fossLED Controllers.

RF 2.4GHz wireless technology, control distance up to 30m (Barrier-free space). Please allow for 12m within areas restricted by obstacles.

IP20 rating, dust resistant only, no resistance to moisture or water.

This product must be installed by a qualified electrician in accordance with instructions provided and in compliance with recognized electrical and safety regulations relevant to the country it is being installed.

## INSTALLATION:

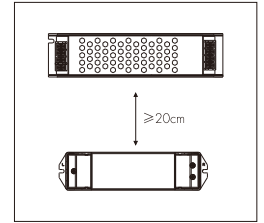
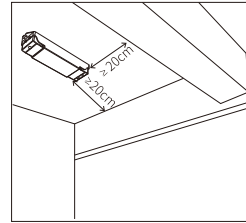
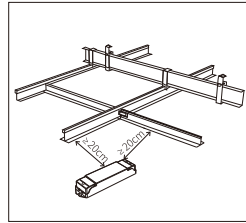
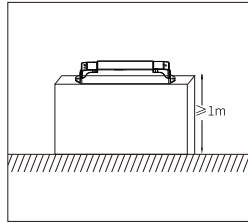
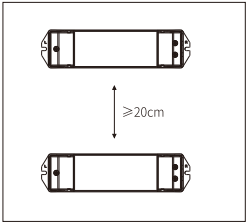
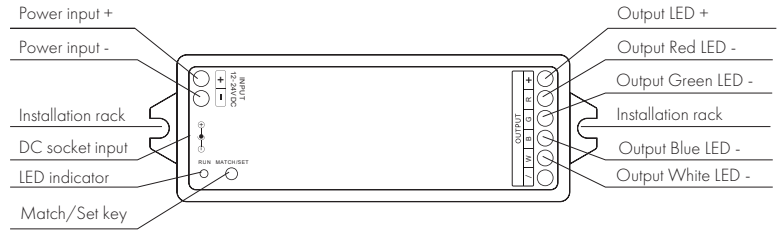
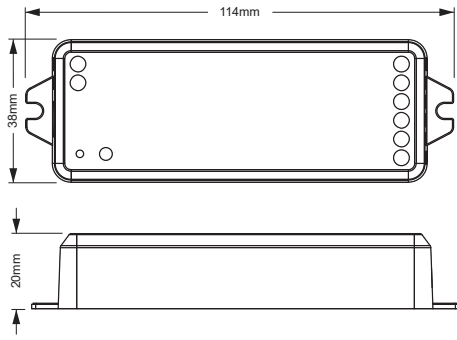

Do not stack products. The distance between products should be  $\geq 20\text{cm}$ , to avoid poor heat dissipation affect lifespan.

Do not put the product on the ground. The installation height should be  $\geq 1\text{m}$ , to avoid shortening the remote control distance due to weak reception signal.

Not to be close to or covered by metal objects, with an interval of  $\geq 20\text{cm}$  to avoid signal attenuation and shorten the remote distance.

Avoid installation at the corner of the wall/beam, with an interval of  $\geq 20\text{cm}$  to avoid signal interference.

The product shall not be installed close to the switching power supply with an interval of  $\geq 20\text{cm}$  to avoid radiation interference of the switching power supply.

## SYSTEM WIRING:

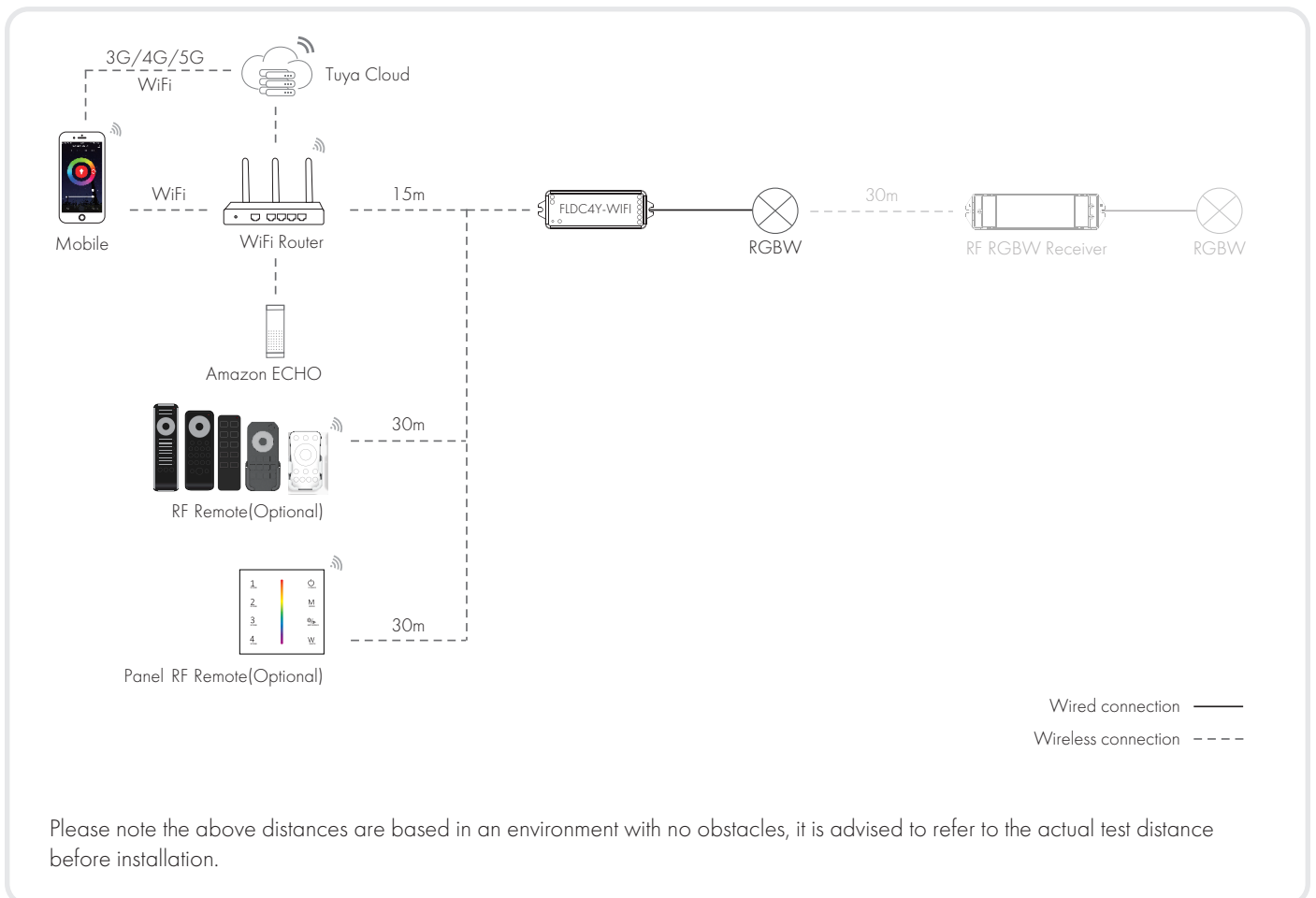

## WIRING DIAGRAMS:

### RGBW

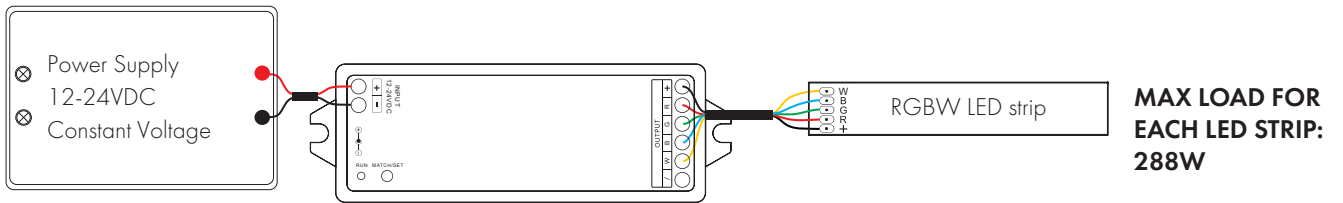

## SMART APP SETUP:

Please download the corresponding Tuya Smart App according to your region by scanning the QR Code opposite. Alternatively visit the App Store or Google Play Store and search "Tuya Smart".



### **Ensure your device is connected to a 2.4GHz WIFI network and Bluetooth is enabled.**

1. Open the Tuya Smart App and login to your existing account or follow the steps to create a new account.
2. Add device using the "+" icon on the top right of the home page.
3. The Receiver should appear, indicated with the fossLED logo and named as per your Strip type selection, for example, "WIFI RGBW".
4. Once the receiver has been selected, please enter your WIFI password as prompted.
5. Wait for a few seconds for the device to be added.

For trouble shooting please follow the below link:

<https://smartapp.tuya.com/tuyasmart/help>

To remove a receiver from your Tuya Smart App: Power cycle ON and OFF on your receiver for 5 consecutive times, the output LED will flash 10 times to confirm the device pairing has been deleted.

## BASIC SMART APP INTERFACE:

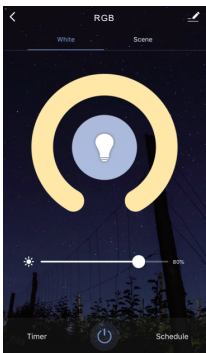

### **White interface**

For RGBW type: Touch brightness slide, adjust white channel brightness.

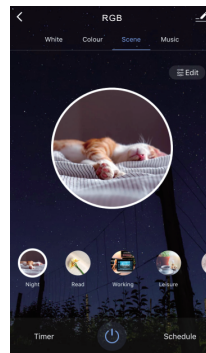

### **Scene interface**

The 1-4 scene is static colour for all light type. The inner colour of these scene can be editable. The 5-8 scene is dynamic mode, such as green fade in and fade out, RGB jump, 6 colour jump, 6 colour smooth.

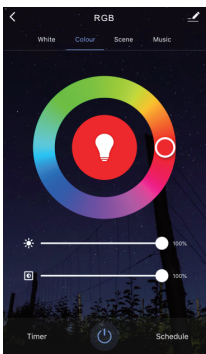

### **Colour interface**

For RGB or RGBW type: Touch colour wheel to adjust static RGB colour. Touch brightness slide to adjust colour brightness. Touch saturation slide to adjust colour saturation, namely gradient from the current colour to white (RGB mixed).

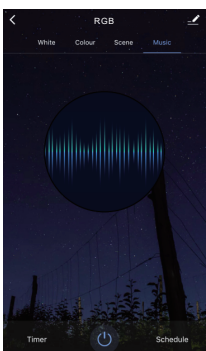

### **Music, Timer and Schedule**

The music play can use smart phone music player or micro-phone as music signal input. The Timer key can turn on or turn off light in the next 24 hours. The Schedule key can add multiple timers to turn on or turn off light according to different time periods.

## MATCHING THE RECEIVER TO A RF CONTROLLER (OPTIONAL):

There are two options for matching and deleting the receiver to a suitable controller, for example FLCT1WY.



MATCH/SET Key

LED indicator

Example receiver: FLCT1WY.



ON/OFF Key

### Use the Receivers Match Key

**Match:** Short press the **MATCH/SET Key**, immediately press the **ON/OFF Key** (single zone remote) or **ZONE Key** (multiple zone remote) on the controller. The **LED indicator** will fast flash a few times, which means the match is successful.

**Delete:** Long press the **MATCH/SET Key** for 20s.

### Use Power Restart

**Match:** Switch off the power to the receiver, then switch the power on, repeat this again. Immediately short press the **ON/OFF Key** (single zone remote) or **ZONE Key** (multiple zone remote) **THREE** times on the controller. The light will flash **THREE** times, which means the match is successful.

**Delete:** Switch off the power to the receiver, then switch the power on, repeat this again. Immediately short press the **ON/OFF Key** (single zone remote) or **ZONE Key** (multiple zone remote) **FIVE** times on the controller. The light will flash **FIVE** times meaning all matched controllers are deleted.

## USING THE WIFI RECEIVER TO CONTROL ANOTHER RF RECEIVER (OPTIONAL):

There are two options for matching and deleting the FLDC4Y-WIFI to another suitable receiver through the Tuya Smart App.

Suitable example additional receiver: FLDC1S.

Tuya Smart App home screen linked to an existing FLDC5Z-WIFI.

LED indicator

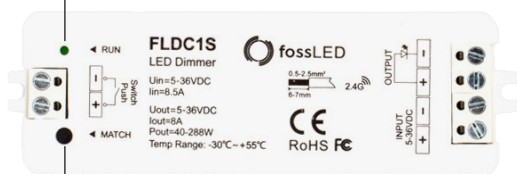

MATCH/SET Key

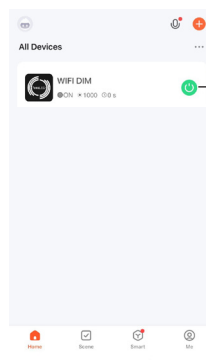

ON/OFF Key

### Use the Receivers Match Key

**Match:** Short press the **MATCH/SET Key**, immediately press the **ON/OFF Key** on the Tuya smart App. The **LED indicator** will fast flash a few times, which means the match is successful.

**Delete:** Press and hold the **MATCH/SET Key** on the receiver for 5s. The **LED indicator** will fast flash a few times, which means the match is deleted.

### Use Power Restart

**Match:** Switch off the power to the receiver, then switch the power on, repeat this again. Immediately short press the **ON/OFF Key** **THREE** times on the Tuya Smart App. The light will flash **THREE** times, which means the match is successful.

**Delete:** Switch off the power to the receiver, then switch the power on, repeat this again. Immediately short press the **ON/OFF Key** **FIVE** times on the Tuya Smart App. The light will flash **FIVE** times meaning the matched controller is deleted.

## TECHNICAL:

Input and Output	
Input voltage	12-24VDC
Input current	12.2A
Output voltage	4 x (12-24)VDC
Output current	4CH, 3A/CH
Output power	4 x (36-72)W, see page 3
Output type	Constant voltage
Package	
Size	L120 x W43 x H35mm
Gross weight	0.073kg
Dimming data	
Input signal	WIFI + RF 2.4GHz
Control distance	30m (Barrier-free space)
Dimming gray scale	4096 (2 <sup>12</sup> ) levels
Dimming range	0 - 100%
Dimming curve	Logarithmic
PWM frequency	1000Hz (default)

Environment	
Operation temperature	Ta: -30°C ~ +55°C
Case temperature (Max.)	Tc: +85°C
IP rating	IP20
Warranty and Protection	
Warranty	5 years
Protection	Reverse polarity Over-heat Short circuit
Safety and EMC	
EMC standard (EMC)	ETSI EN 301 489-1 V2.2.3 ETSI EN 301 489-17 V3.2.4
Safety standard (LVD)	EN 62368-1:2020+A11:2020
Radio Equipment (RED)	ETSI EN 300 328 V2.2.2
Certification	CE,EMC,LVD,RED